



*ENJOY e-YACHTING WITH CMC MARINE*



# NUMARINE

32XP fitted with  
CMC Marine Systems



Picture courtesy of Numarine photo archive

**INTEGRATED  
STABILIZATION SYSTEMS** 01

---

**STABILIZERS** 05

---

**THRUSTERS** 21

---

**STEERING SYSTEMS** 23

---

**ARGO** 25

---

**R&D** 27

---

**REFIT** 31

---

**TECHNICAL DATA** 34

---

# INTEGRATED STABILIZATION SYSTEMS

## FULL CONTROL OF THE YACHT MOTION

The Vessel's motion at sea is influenced by waves and wind, and the amount of roll, pitch and yaw can negatively affect both the passengers comfort and the operational performance, impacting on safety, speed, fuel efficiency and operating range.

By focusing on leading-edge technologies such as electrical motors and digital control, CMC Marine's has established its industry leadership for motion control, through a full range of solutions.

CMC Marine's portfolio of electrically-actuated solutions now includes: Fin Stabilizers, Steering Systems and Thrusters. They can work all together to deliver the most effective, performing and reliable motion-control platform on the market.

## A HIGH-TECH CORE

Every system is an assembly of the most advanced, robotic-industry standard technologies, made to work with the highest standards of performance, accuracy, fast response, reliability and energy efficiency.

All our systems can operate independently whenever required, but maximum performance is achieved when they work together, controlled by the same algorithm, processor and motion sensors.

CMC Marine's patented software is the core of this integration: 100% developed internally, continuously evolved to stay ahead of the evolution of Yachts' technology and of our Clients' requirements.

### YAW

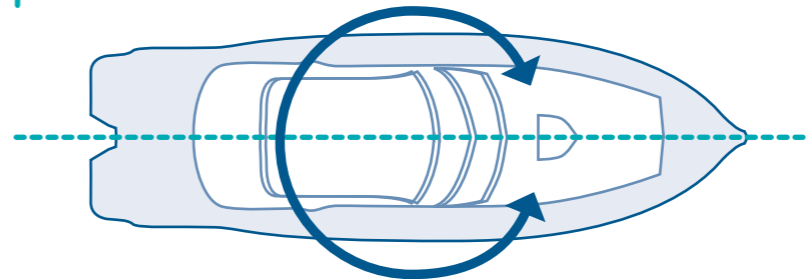

### PITCH

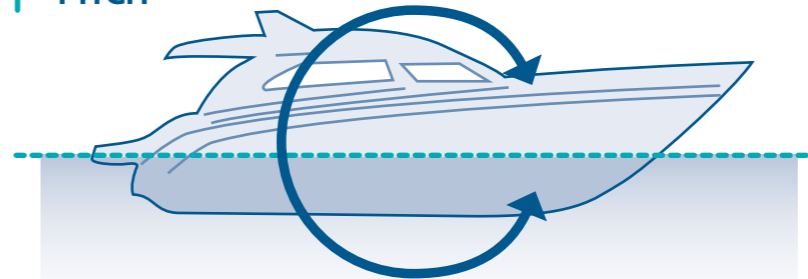

### MOTION

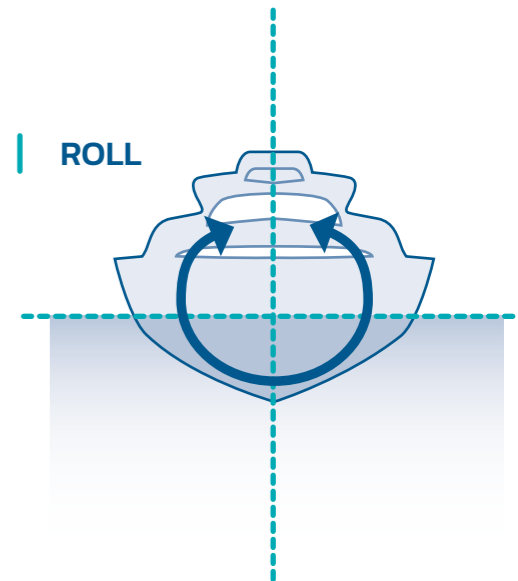

*Benetti*

Oasis 40M fitted with  
CMC Marine Systems

Picture courtesy of Benetti photo archive



## SUPERIOR PERFORMANCE FOR YOUR YACHT

### WITH OUR INTEGRATED STABILIZATION SYSTEM

- ▶ Best-in-class roll reduction both Underway and At Anchor, with softer (lower acceleration) yacht motion for unequalled comfort.
- ▶ Adaptive mode tracks weather conditions and adjusts system operational parameters automatically, for optimal performance at all times.
- ▶ Optimal performance delivered in a broader range of operating conditions (different load conditions, wave length and period, etc.).
- ▶ High efficiency (>85%) means lower power demand on generators and reduced energy consumption.
- ▶ Minimal heat generation (<45 °C even in the most demanding condition): no cooling, no air extraction required.
- ▶ Silent! Negligible noise and vibration, often installed under Owner's or VIP's beds.
- ▶ Smaller fin surfaces if compared to traditional systems.
- ▶ Optional features available, to accommodate specific users' needs (including reduced power absorption mode, flip to counteract anchor-creep and many more).

# STABILIZERS



## STABILIS ELECTRA

electric fin stabilizer

**Stabilis Electra - the 1st electrically actuated stabilizing system - EP n. 3172394**

Stabilis Electra™, was designed to offer a higher dynamic and more accurate response, with less noise, less power consumption and greater reliability. As CMC Marine has gained and maintained a leading role in stabilization, nowadays Stabilis Electra™ is a must-have feature and the market reference, despite numerous attempts to copy it.



### INSTANT START&STOP

- ▶ Stabilis Electra can be started and is immediately active as it does not require a long start-up time like other systems.



### ECO FRIENDLY

- ▶ No risk of mineral oil contamination, or other pollutants.
- ▶ More than 90% manufactured with recyclable materials.
- ▶ Powered by top quality electric motors, Stabilis Electra is more efficient and needs significantly lower electrical power than other systems (>85%).



### COMFORT ON BOARD

- ▶ Best-in-class roll reduction both Underway and At Anchor, with softer (lower acceleration) yacht motion for unrivalled comfort.
- ▶ The Adaptive mode adjusts system operational parameters automatically, for optimal performance at all time. It checks the weather conditions constantly for optimal performance in all operating conditions (different load conditions, wave length and period, etc...).



### LOWER MAINTENANCE

- ▶ Zero maintenance required on electrical motor and gearbox.

## TEST RESULTS

for a 23 m LOA yacht equipped with two 0.8 sqm fins.

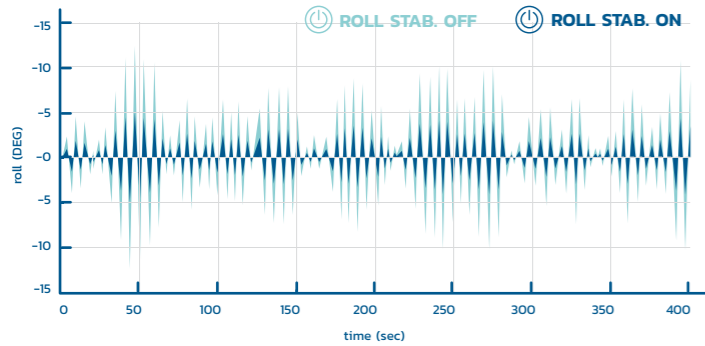

### AT ANCHOR PERFORMANCE

Wave Height **0,75 m**

Average Roll **- 58%**

Peak roll **- 84%**

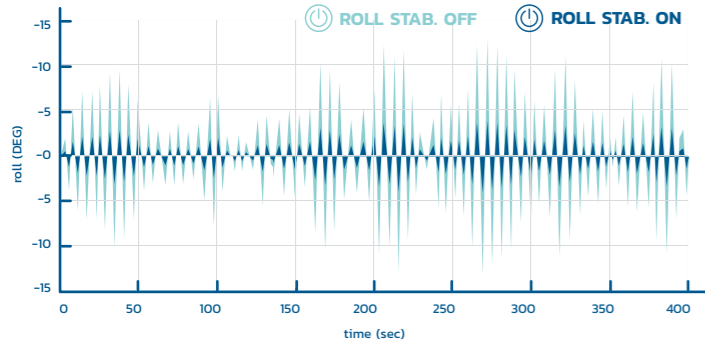

### UNDERWAY PERFORMANCE at cruising speed

Wave Height **1,50 m**

Average Roll **- 83%**

Peak roll **- 90%**

**SANLORENZO**

*SL78 fitted with  
CMC Marine Systems*



## TEST RESULTS

for a 30 m LOA yacht equipped with 1.85 sqm fins.

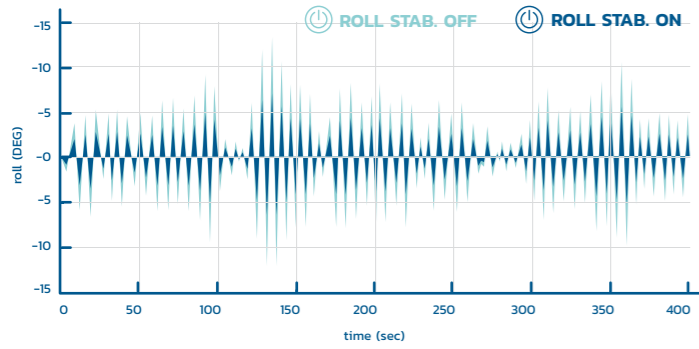

### AT ANCHOR PERFORMANCE

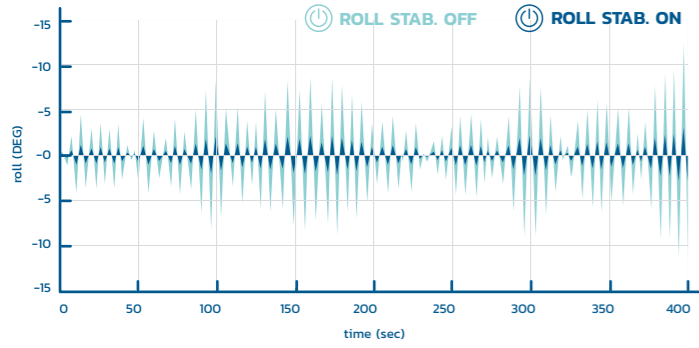
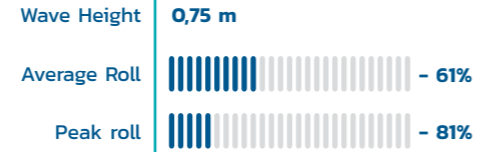

### UNDERWAY PERFORMANCE at cruising speed

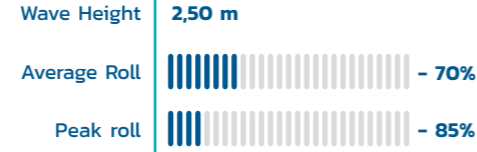

Grande 35 fitted with  
CMC Marine Systems

Picture courtesy of Azimut Photo archive

## TEST RESULTS

for a 50 m LOA yacht equipped with 3.15 sqm fins.

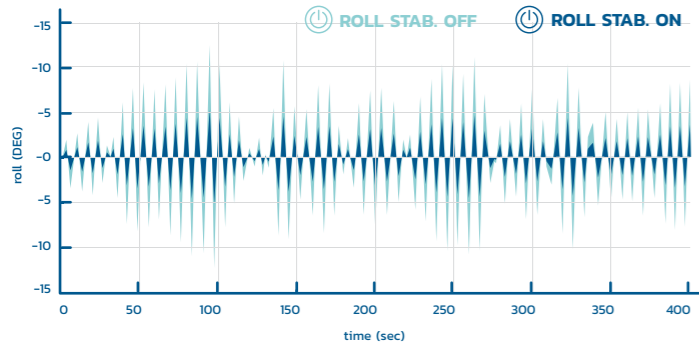

### AT ANCHOR PERFORMANCE

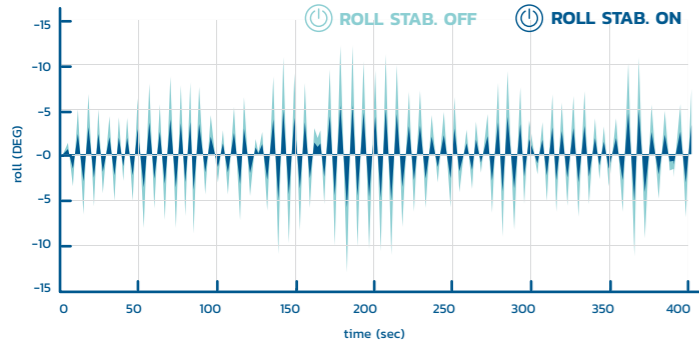
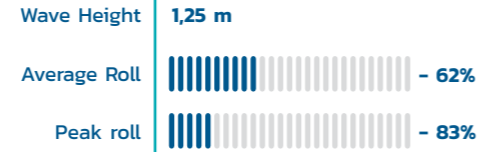

### UNDERWAY PERFORMANCE at cruising speed

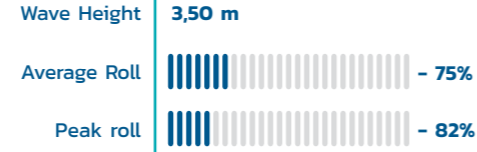

Mangusta 42 fitted with CMC Marine Systems

Picture courtesy of Overmarine Group photo archive



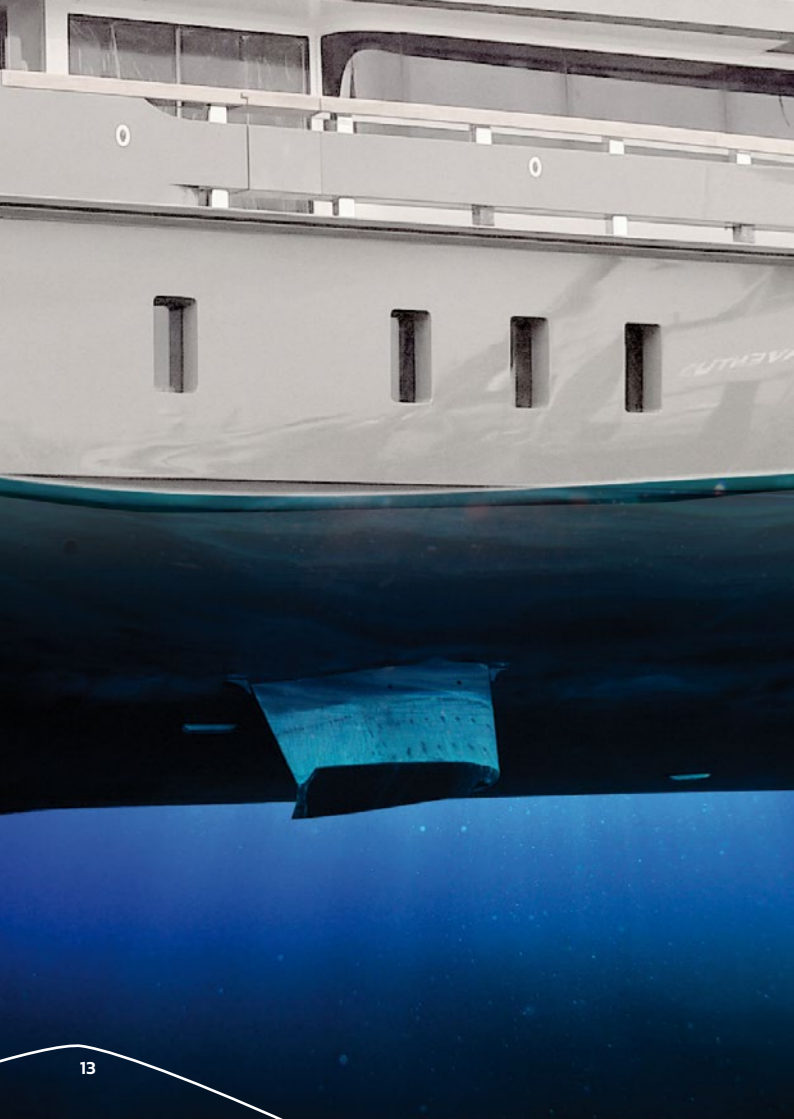

34%  
MARKET SHARE

MORE THAN  
1000 INSTALLATIONS

With 34% global market share (2015–2018) for yacht up to 35 m LOA, CMC Marine is the global leader of stabilisation.



OUR CUSTOMERS ARE  
OUR BEST REFERENCES

Being the preferred supplier of the major superyacht builders, CMC Marine has quickly accrued an impressive reference list.



TANSU

*Sexyfish fitted with  
CMC Marine Systems*

Picture courtesy of Tansu photo archive

**STABILIS ELECTRA™ LINE:  
THE RIGHT SOLUTION  
FOR EVERY YACHT**

Every yacht is different but the goal is the same: provide the best comfort on board. Reducing the roll alone is not enough, it's important to also minimize the acceleration (because this is what makes people uncomfortable and tired). Stabilis Electra's fast reaction time and smooth operation manage to reduce roll and acceleration like no other system, providing the solution tailored to the yacht's needs thanks to a wide product range.



## STABILIS ELECTRA™ HS AND LR SYSTEMS

CMC Marine has a solution for every yacht, no matter the size. Stabilis Electra™ HS system is designed for planing and semi-displacement hulls from 20 m (65 ft) up to over 50 m (164 ft), Stabilis Electra™ LR system for displacement hulls with fins up to 6 sqm.

HS system

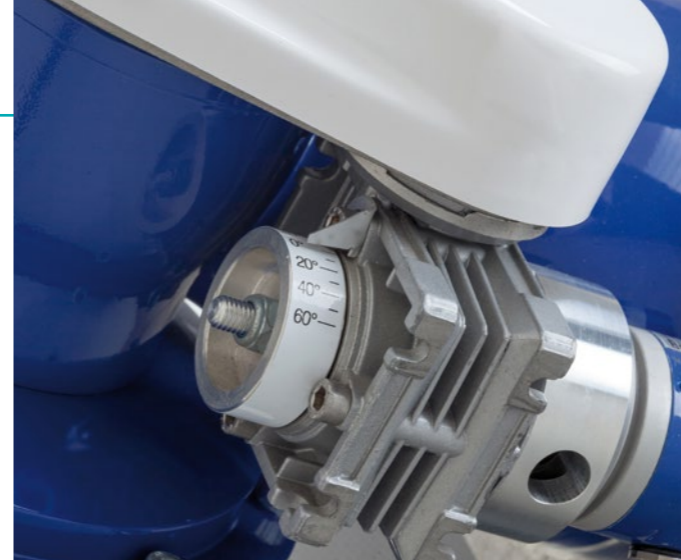

LR system

COMPACT ELECTRIC  
STABILIZERS FOR  
YACHTS 12 M AND UP!

**waveless**  
DIVISION OF CMC MARINE GROUP





ROSSINAVI

*Param Jamuna fitted with  
CMC Marine Systems*

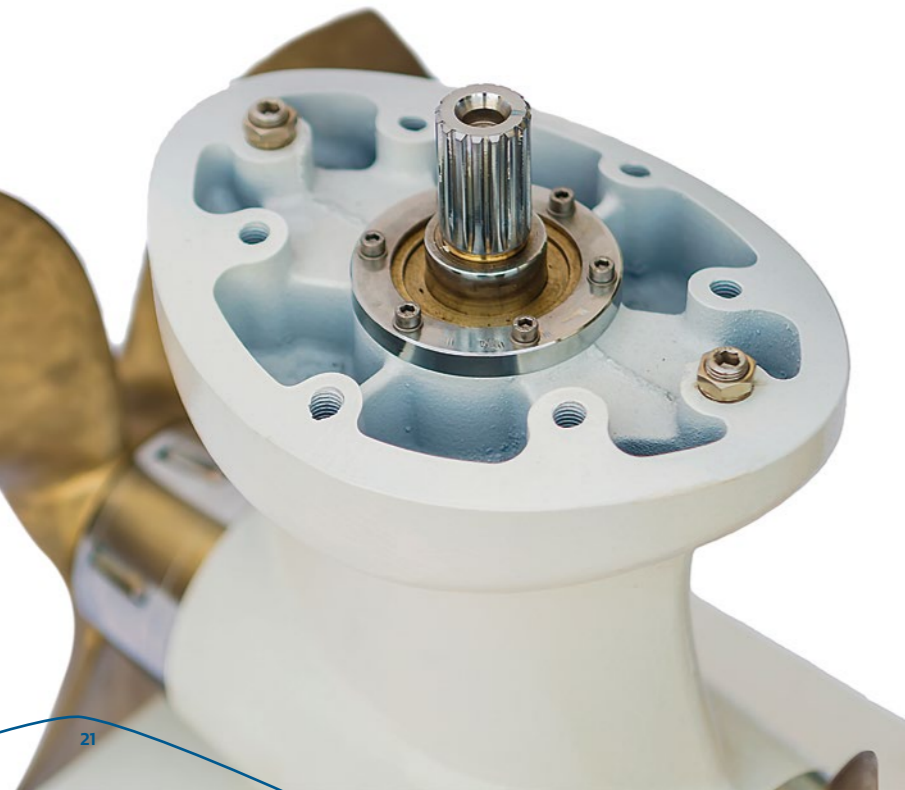

## THRUSTERS

Dualis Electra™ is the range of high performance electrical thrusters developed by CMC Marine that offer numerous advantages:



**HIGH THRUST TO POWER RATIO**



**MINIMUM VOLUME AND WEIGHT**



**MINIMUM MAINTENANCE**



**MINIMUM NOISE LEVEL**



**MAXIMUM RELIABILITY AND DURABILITY**

### COMMERCIAL GRADE THRUSTERS DEVELOPED FOR YACHTS:

- ▶ Counter rotating bronze propellers.
- ▶ High quality casting and mechanics.
- ▶ Corrosion protection.
- ▶ Higher thrust-to-power ratio than competitors.
- ▶ Propeller shaft in high-grade stainless steel.

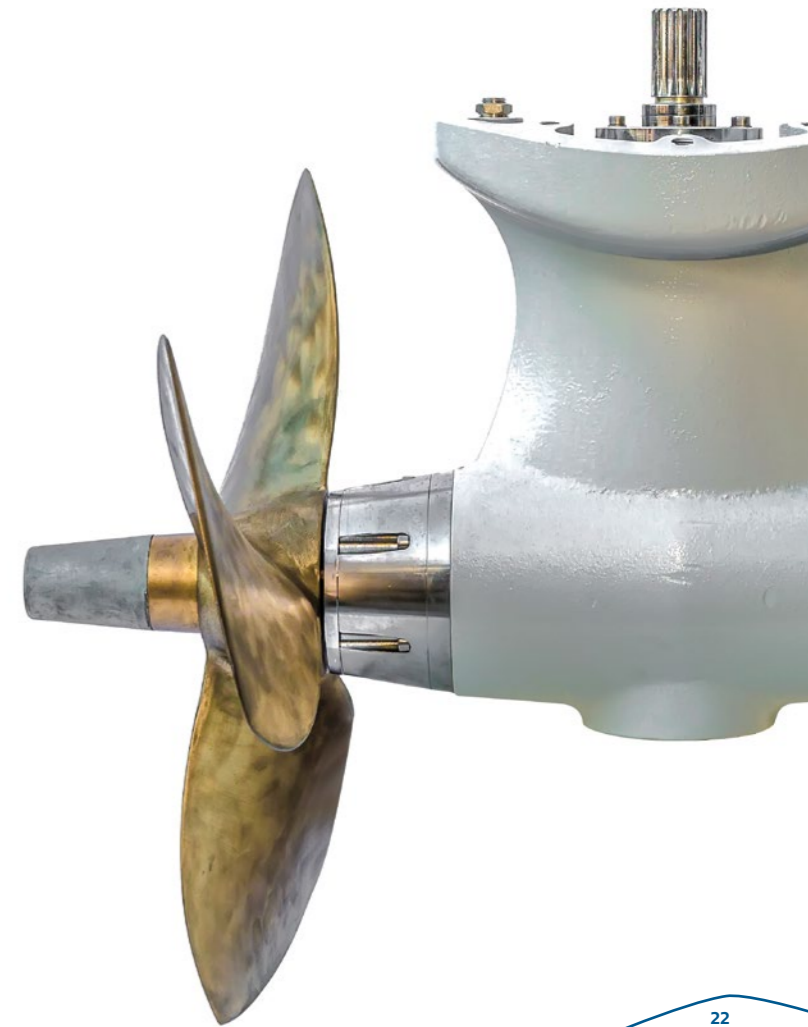

# STEERING SYSTEMS

Directa is the world's first fully electric steering system for superyachts from 22 m (72 ft) up to 80 m (262 ft).

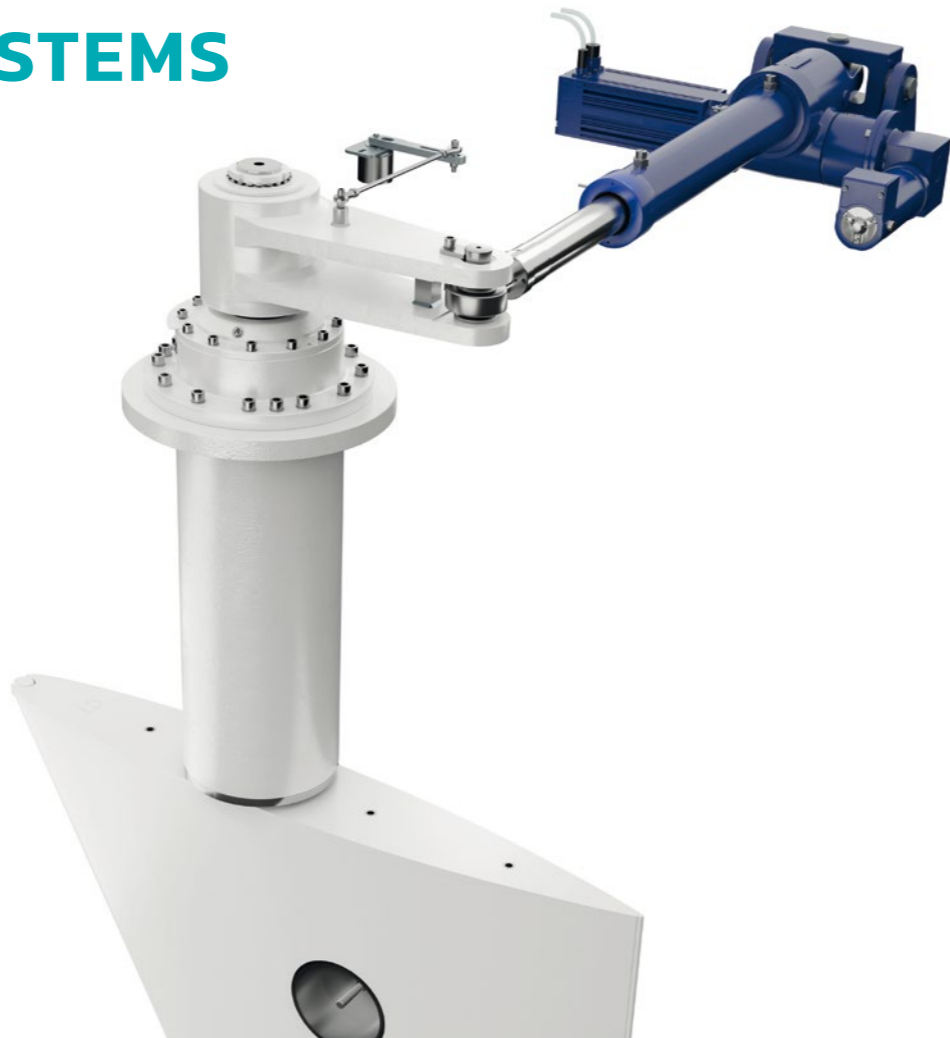

FULLY ELECTRIC  
STEERING GEAR

Directa is compatible with all other CMC Marine products, including Argo Integrated Ride Control, and any autopilot system, allowing independent control of the rudders.



## INTEGRATED RIDE CONTROL

CMC Marine Argo advanced control system can control up to 8 independent surfaces, integrating fin and rudder control for improved yacht stability. Thanks to Argo it is possible to control roll, pitch and yaw together, improving seakeeping, especially with following seas.

The new Argo Integrated Ride Control System is the latest result of CMC Marine's constant research for the next innovation and our R&D capability.

Argo is the world's first system to integrate stabilizers, trim and rudder control, improving the yacht's total stability and efficiency. With Argo, CMC Marine created a system that can deliver maximum comfort on-board, better course stability and steering control, maintaining the yacht stable during navigation and manoeuvring. Thanks to Argo displacement boats can finally get rid of the constant course correction problem, especially with following seas.

Better course keeping and control also improves the yacht's fuel efficiency and reduces the stresses on the fins and rudders, thus extending the components lifetime.

## INTEGRATED SYSTEMS

Suitable for yachts and superyachts up to 80 m (262 ft).

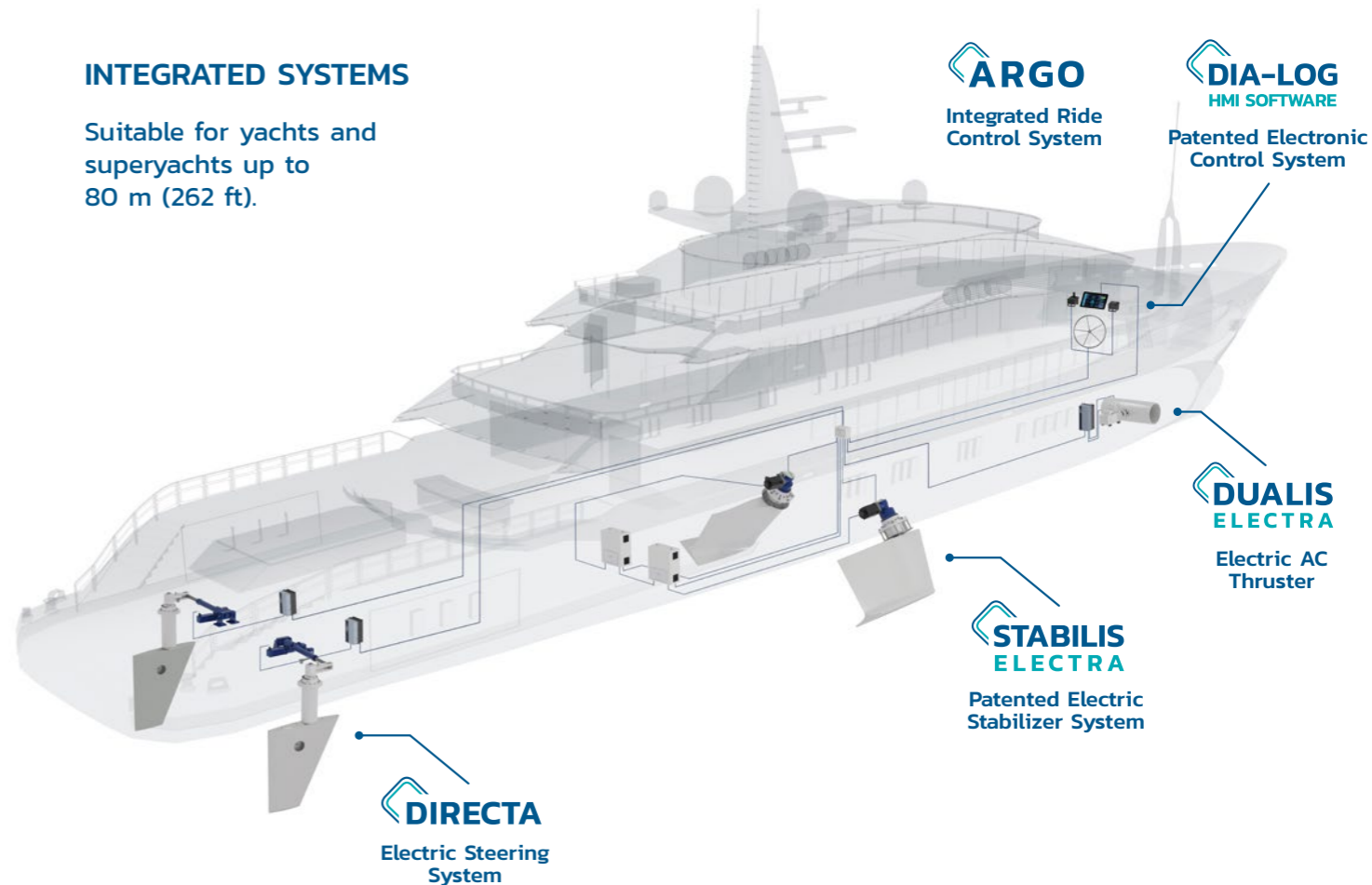

# R&D

Innovation is the core of CMC Marine. Our team of highly skilled engineers is dedicated full time to R&D, focusing on delivering the next step in product innovation, keeping CMC Marine always one step ahead of our competitors. Some of the innovations under development include a new 6 m<sup>2</sup> fin for giga yachts and a PC-Box based control hardware, enabling remote assistance and faster and more sophisticated control software.



## DIA-LOG HMI SOFTWARE

Dia.Log HMI software EP n. 2669177 ; 10,077,098

### PATENTED ELECTRONIC CONTROL SYSTEM

Innovation is the core of CMC Marine. Our team of highly skilled engineers is dedicated full time to R&D, focusing on delivering the next step in product innovation, keeping CMC Marine always one step ahead of our competitors.

DIA-LOG® Control System enables the customer to take all the advantages of the Stabilizers System. The user has the complete control of Fins System through the touch screen (and backup control panel) located in wheelhouse.

Predictive algorithm monitors operating conditions continuously and adjusts the system's parameters automatically, to deliver optimal roll reduction performance at all times.

### SOFTWARE OPTIONS

#### FLIP

Rotate fins by 180° while At Anchor to prevent anchor walk.

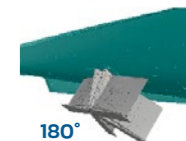

#### ECO

Reduce energy consumption to extend batteries duration. Reduce power absorption to approximately 60% of the standard, by limiting the system responsiveness.



#### DOCK

Limits the maximum fin rotation angle.

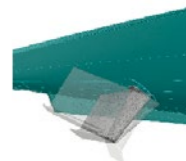

#### MSS

Keep the anchor mode active at low maneuvering speeds.







*Mangusta GranSport 54 fitted with  
CMC Marine Systems*

*Picture courtesy of Overmarine Group photo archive*

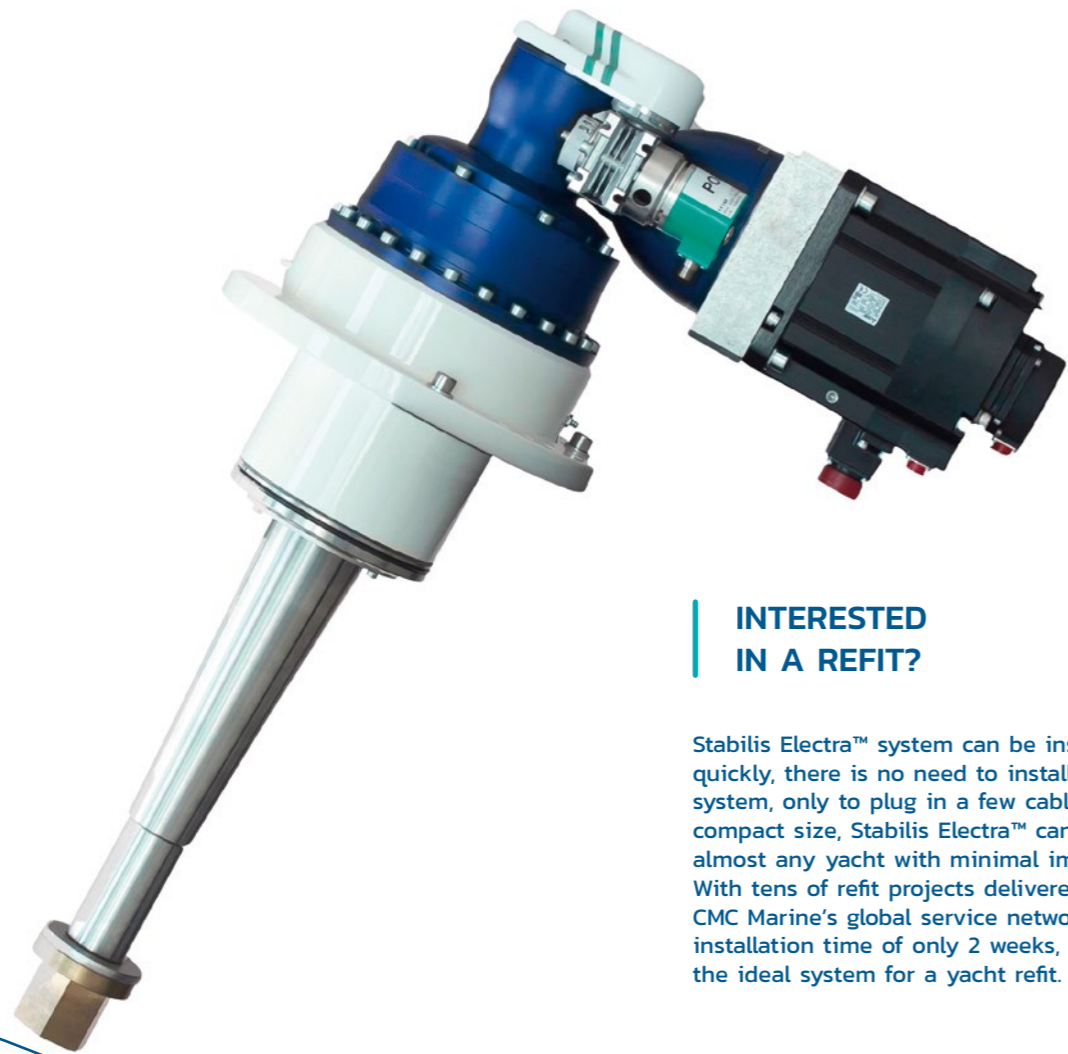

## INTERESTED IN A REFIT?

Stabilis Electra™ system can be installed easily and quickly, there is no need to install a complex hydraulic system, only to plug in a few cables. Thanks to the compact size, Stabilis Electra™ can be installed on almost any yacht with minimal impact on space. With tens of refit projects delivered every year by CMC Marine's global service network and an average installation time of only 2 weeks, Stabilis Electra™ is the ideal system for a yacht refit.



### PERFORMANCE

- ▶ Advanced and reliable technology.
- ▶ High dynamic response: greater comfort with smaller fin surfaces compared to the traditional systems.
- ▶ Adaptive mode for optimal performance in all weather conditions.
- ▶ Outstanding roll reduction performance, both Underway and At Anchor.
- ▶ High efficiency: lower power demand on generators and minimal heat generation (no cooling required).
- ▶ Silent! Negligible noise and vibration, often installed under Master cabin bed.



### INSTALLATION

- ▶ Quick and easy installation: no power pack, no plumbing, no pipes and fittings, no noise insulation, no oil flushing.
- ▶ No need to increase the generators size.
- ▶ Space saving: smaller and lighter than any other stabilization system.
- ▶ Very simple installation on existing vessels, the ideal solution for retrofits.



### MAINTENANCE

- ▶ Very high Time Between Overhauls (TBO) Lower maintenance requirement than any other competitor: no hydraulic components, no pipes, no oil flushing.
- ▶ Extensive Service Network: maintenance and support available wherever you are cruising, remote assistance available (optional).



### GREEN

- ▶ No risk of oil spilling or water pollution.
- ▶ More than 90% manufactured with recyclable materials.
- ▶ Reduced power absorption.

**SANLORENZO**

SL118 fitted with  
CMC Marine Systems



Picture courtesy of Sanlorenzo photo archive

## STABILIZERS

**STABILIS  
ELECTRA**  
electric fin stabilizer



	MODEL	LOA-INDICATIVE	POWER	FIN SIZE
HS	HS60	23-35 m	5,0-7,0 kW	1,00-1,20-1,40 sqm
	HS80	30-40 m	5,0-7,0 kW	1,60-1,85 sqm
	HS120	40-50 m	7,0-9,0-11,0 kW	1,85-2,00-2,35-2,50 sqm
	HS160	>50 m	15,0 kW	3,00-3,30-3,50 sqm
LR	LR70	30-38 m	7,0 kW	1,50-1,70 sqm
	LR90	35-47 m	7,0-9,0 kW	1,90-2,10-2,35 sqm
	LR150	40-50 m	11,0 kW	2,70-2,90 sqm
	LR170	40.50 m	15,0 kW	3,15-3,50 sqm
	LR200	>50 m	22,0 kW	3,70-4,00-4,30-4,50 sqm

# THRUSTERS



EA

MODEL	RATED POWER	PROPELLERS Ø	TUNNEL Ø	THRUST
TP20	22 kW	280 mm	300 mm	350 kgf
TP30	30 kW	340 mm	355 mm	470 kgf
TP40	37 kW	380 mm	400 mm	560 kgf
TP50	45 kW	430 mm	450 mm	700 kgf
TP60	55 kW	480 mm	500 mm	830 kgf
TP75	75 kW	530 mm	550 mm	1200 kgf
TP90	90 kW	580 mm	600 mm	1350 kgf
TP100	110 kW	630 mm	655 mm	1700 kgf
TP130	130 kW	660 mm	690 mm	2090 kgf
TP160	155 kW	720 mm	740 mm	2500 kgf
TP200	195 kW	860 mm	884 mm	3150 kgf

# STEERING SYSTEMS



DIR

MODEL	MOTOR POWER	EMERGENCY MOTOR	THRUST	COMPLIANCE
DIRECTA 80	0,50 KW (each)	Manual	11 kN (each)	RINA/CE
DIRECTA 100	0,65 KW (each)	24V DC / 150 W	20 kN (each)	RINA/ABS
DIRECTA 120	1,00 KW (each)	24V DC / 150 W	30 kN (each)	RINA/ABS
DIRECTA 140	2,50 KW (each)	24V DC / 300 W	40 kN (each)	RINA/ABS
DIRECTA 150	5,00 KW (each)	24V DC / 300 W	55 kN (each)	RINA/ABS

## CMC MARINE INTERNATIONAL PRESENCE

CMC Marine headquarters are in Milan (Italy) with production facility is located in Pisa (Italy) and subsidiaries in London (UK) and Ft Lauderdale (USA). A global network of Service Centers and Certified Professionals guarantees immediate and professional assistance to our customers.



### ITALY

**CMC Marine srl**  
Via Francia, 16  
Cascina, Pisa 56021

info@cmcmarine.com  
+39 050 81 55 00



### ITALY

**CMC Marine srl**  
Via San Vittore, 40  
Milano 20123

info@cmcmarine.com  
+39 050 81 55 00



### USA

**CMC Marine CORP.**  
240 SW 30th ST Suite A1  
Ft. Lauderdale, FL 33315

service@cmcmarine.us  
+1 954 669 3656



### UK

**CMC Marine Ltd**  
Unit 11A, Saltmarsh Building  
Cobbs Quay Marina Woodlands  
Avenue Poole Dorset BH15 4EL

info.uk@cmcmarine.com  
+44 1202 817144

## A GLOBAL SERVICE NETWORK

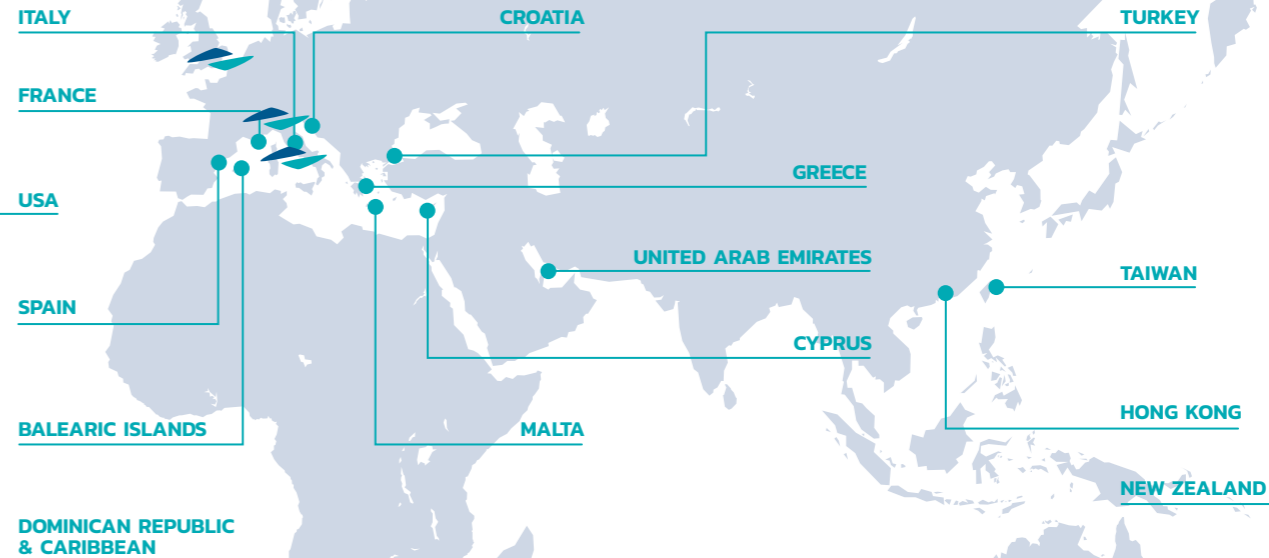

CMC Marine provides seamless service to their customers through an extended worldwide Service Network. For more information visit: [www.cmcmarine.com/service](http://www.cmcmarine.com/service)

*Benetti*

Crystal fitted with  
CMC Marine Systems



Picture courtesy of Benetti photo archive

## CMC MARINE'S PARTNERS





cmcmarine.com

FOLLOW US

